

Model München Riem



Security level: Class I according to EN 1143-1

SPECIAL FEATURE - key cabinets with extendible walls including 10-hook bars. Colourful, unnumbered, height-adjustable hook bars.

Suitable for the storage of:
 keys

Description
 München Riem serie - key safes.

Body: multi-walled body (38 mm thick)
Door: multi-walled door construction (84 mm thick)
Locking: 4-way locking bolt system

Standard option
Lock: high security key lock I class VdS with two keys (95 mm)
Boltwork handle: knob faced with the door
Hinges: internal
Door opening angle: 90°
Mounting holes: 2 holes in the floor
Colour: RAL 7035 (light grey)



Model München Riem

Art. No.	Model	Outer dimensions*			Inner dimensions			Door light		Anchoring		Hooks in total	Weight
		Height mm	Width mm	Depth mm	Height mm	Width mm	Depth mm	Height mm	Width mm	Bottom number	Backwall number	Number	Kg
16000	München Riem	636	496	500	545	424	381	530	354	2	0	270	170
16001	München Riem	836	496	500	745	424	381	730	354	2	0	450	200
16002	München Riem	1036	496	500	945	424	381	930	354	2	0	630	260
16003	München Riem	736	736	500	645	664	381	630	594	2	0	900	260
16004	München Riem	836	736	500	745	664	381	730	594	2	0	1050	275
16005	München Riem	1036	736	500	945	664	381	930	594	2	0	1500	325
16006	München Riem	1236	736	500	1145	664	381	1130	594	2	0	1950	390
16007	München Riem	1536	736	500	1445	664	381	1430	594	2	0	2890	475
16008	München Riem	1536	736	500	1445	664	381	1430	594	2	0	3230	490
16009	München Riem	1836	736	500	1745	664	381	1730	594	2	0	3570	630
16010	München Riem **	1836	1200	500	1745	1132	381	1730	1022	2	0	5040	800

* excluding hinges, handles and fittings ** 2-door

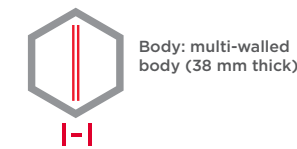

Closure options

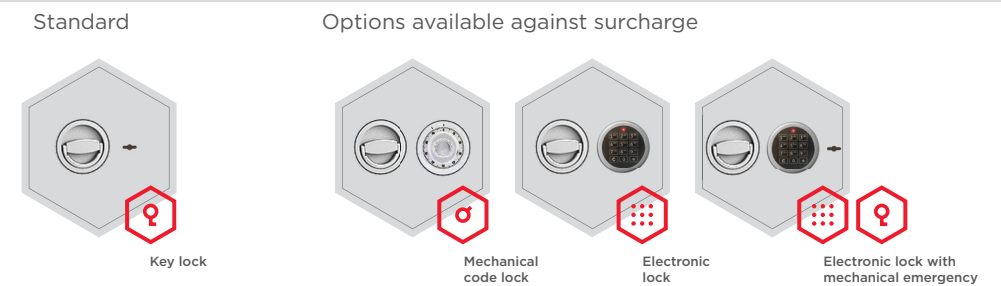

Accessories available against surcharge

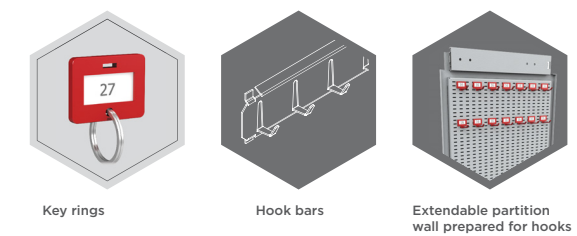

Colour options without surcharge







All information concerning weight, color and dimensions are noncommittal and subject to errors and changes. Minor deviations are conditional on the production process. Technical changes, modifications and printing errors reserved. Safes may be top-heavy, during commissioning, please exercise appropriate caution in accordance with the installation guide. Pictograms are not technical description of the product.

The picture shows an example of a key safe - model Düsseldorf Mettman Rattingen Art. no. 16101



Key rings option against surcharge.



Color	Art. no.
 blue	Art. 15023.00
 green	Art. 15023.01
 yellow	Art. 15023.02
 red	Art. 15023.03
 black	Art. 15023.04

Art. No.	Model	Hook bars			Hooks on hook bar			Partition wall Number	Hooks in total Number
		Back wall Number	Door Number	Partition wall Number	Back wall Number	Door Number	Partition wall Number		
16000	München Riem	-	-	6 (3*)	-	-	10	5	270
16001	München Riem	-	-	10 (5*)	-	-	10	5	450
16002	München Riem	-	-	14 (7*)	-	-	10	5	630
16003	München Riem	-	-	12 (6*)	-	-	10	8	900
16004	München Riem	-	-	14 (7*)	-	-	10	8	1050
16005	München Riem	-	-	20 (10*)	-	-	10	8	1500
16006	München Riem	-	-	26 (13*)	-	-	10	8	1950
16007	München Riem	-	-	34 (17*)	-	-	10	9	2890
16008	München Riem	-	-	38 (19*)	-	-	10	9	3230
16009	München Riem	-	-	42 (21*)	-	-	10	9	3570
16010	München Riem	-	-	42 (21*)	-	-	10	13	5040

* one-sided partition wall equipped with hook bars (on the hinge side)

Hook bars

Standard

Art. no. 02010

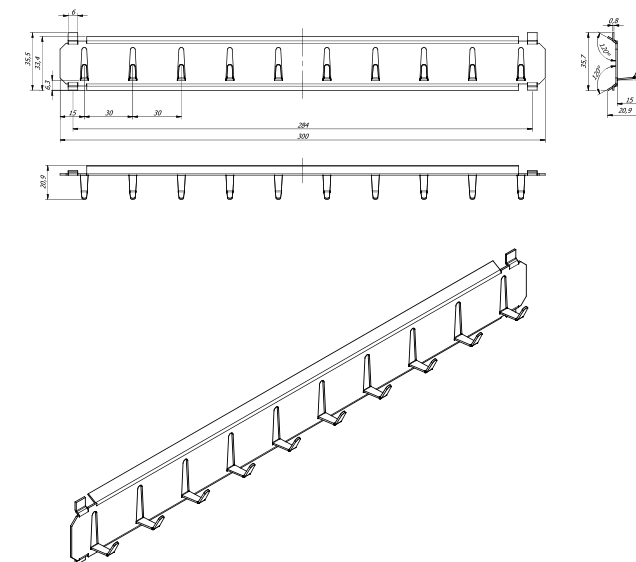

Hook bars options available against surcharge

Art. no. 02011

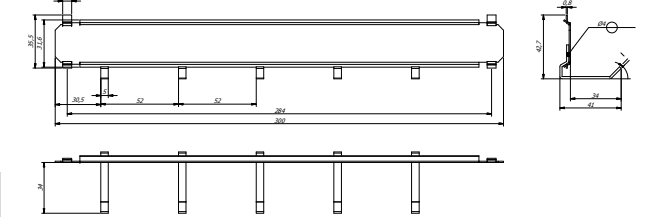

Art. no. 02012

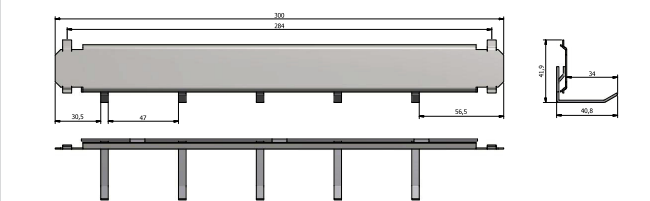

Art. no. 02013

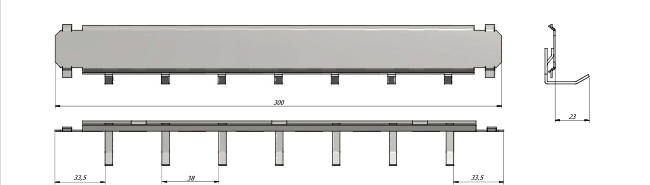

Art. no. 02014

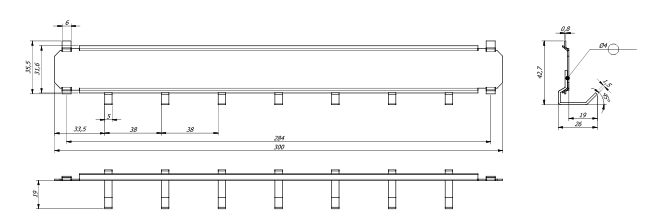

Bar

